

522242











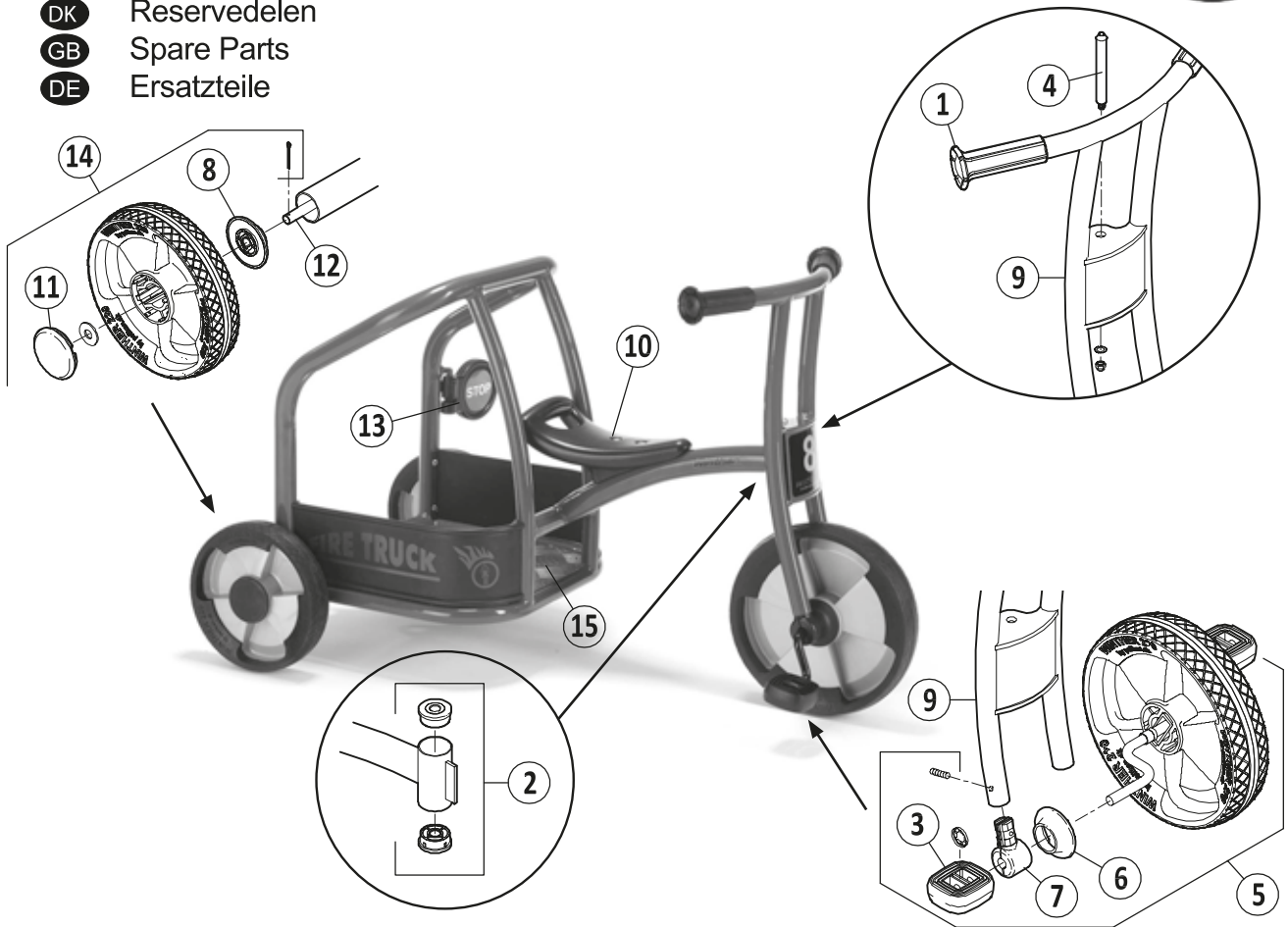









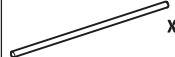













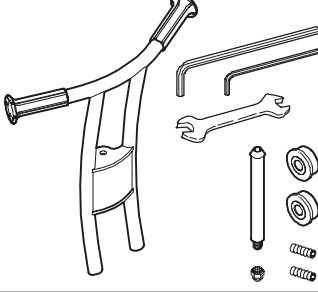

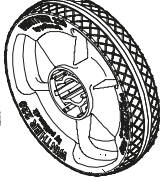

EN 71

ASTM
F963

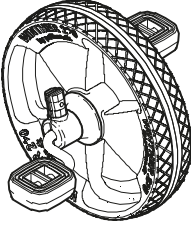

- DK** Reservedelen
- GB** Spare Parts
- DE** Ersatzteile

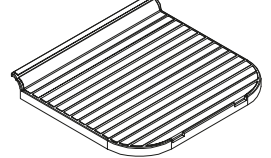

Pos.		Pos.		Pos.	
1	 x2	6	 x2	11	 x2
2	 x2	7	 x2  x2  x1	12	 x1  x2  x2
3	 x2  x2	8	 x2	13	 x1  x1  x1
4	 x1  x1  x1  x2  x1	9		14	     
5	 	10	  	15	  



522242



EN 71

ASTM
F963



- DK Reservedelen
- GB Spare Parts
- DE Ersatzteile

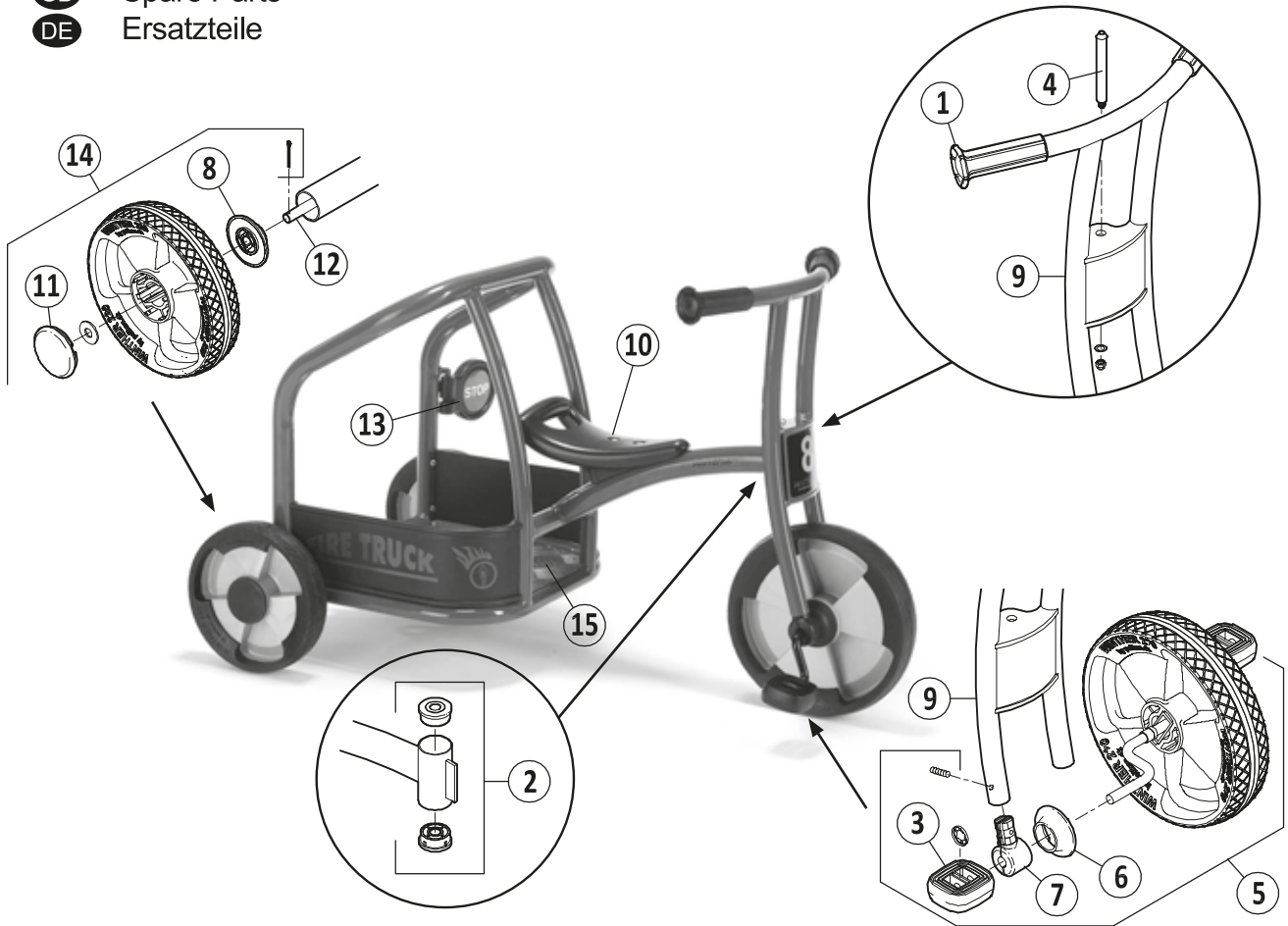

563.00					
Version					
Pos.	1.1 - 2.0				
1	525591				
2	525636				
3	525600				
4	525592				
5	525624				
6	525637				
7	525639				
8	525640				
9	525708				
10	525709				
11	525641				
12	525606				
13	525710				
14	525605				
15	525711				
16	-				
17	-				
18	-				

